

FA-1 Unloading Flowmeter

Manual



1. Overview

1.1 Introduction

Unloading flowmeter is mainly used for measuring gravity flow unloading of oil.

The type flowmeter can be applied to:

- Regular unloading of oil at gas stations
- Oil receiver (tanker)
- Segmented unloading
- Oil recovery
- Calibration of tank gauge

1.2 Composition of unloading flowmeter

- Display and Metering module (UNI, intrinsically safe design, built in a rechargeable lithium battery power supply, after charging 500 times, the remaining capacity of about 65%)
- Turbine (DN80)
- The oil outlet is viewable
- Vacuum fill valve
- Temperature sensor
- Wet and dry sensor

1.3 Unloading flowmeter interface specification

- Inlet interface: 3-inch quick connector Negative end (DN80)
- Oil outlet interface: 3-inch quick connector (DN80)
- It is convenient to connect various caliber discharge pipes and joints with the reducer

1.4 Data Communication

- Unloading flowmeter uses a wireless Bluetooth connection to transfer data to a mobile phone or computer in the form of an editable excel spreadsheet.
- The metering parameters and configuration files of the unloading flowmeter can be uploaded separately to facilitate the testing of the flowmeter (periodic inspection, inspection and diagnosis)
- Display - Metering module (UNI) manages unloading metering related operations and fault maintenance. UNI module operating temperature range: -25°C to 55°C .

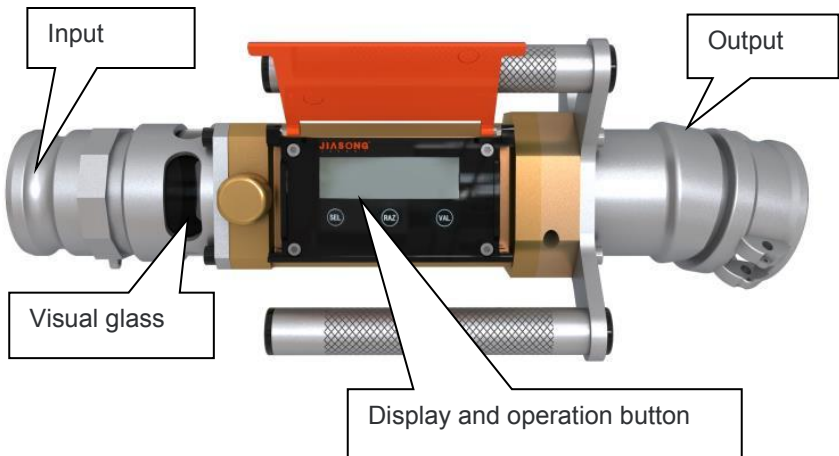

1.5 Basic parameter

Model	Size DN	Accuracy %	Flow Rate L/min	Max. Pressure MPa	Viscosity Range mm ² /s	Weight Kg
FA-1	80	±0.2	130-1300	0.5	≤13	6

1.6 Applicable medium

Gasoline, diesel, kerosene, ethanol gasoline and other oil products

1.7 Environmental Conditions

- a) Temperature: -25℃~+55℃
- b) Relative Humidity: ≤93%
- c) Atmospheric pressure: 86kPa~106kPa

1.8 Brief introduction of metering module button function



Product selection
Setting



Save
View historical data



Confirm Key
Backlight, click the back light for 20 seconds

2. Caution

2.1 Mobile installation

Requirement for connection between unloading flowmeter inlet and discharge manual valve:

- The length shall not be greater than 80mm, and the diameter shall not be less than 80mm;
- The vertical Angle between the axis of the flowmeter and the horizontal plane is 15 degrees

2.2 Fixed installation

- The unloading flowmeter shall be installed on the vertical plane passing through the axis of the oil outlet, and the Angle between the axis of the flowmeter and the horizontal plane shall be 15 degrees;
- The connection requirements between the inlet of the flowmeter and the manual valve of oil unloading: the pipe diameter shall not be less than 80mm, and the length shall not be greater than 80mm. If the length exceeds 80mm, it can only be used for complete oil unloading (not for sectional oil unloading).
- The connection requirements of the oil outlet of the flowmeter: the diameter of the oil pipe shall not be less than 80mm, and the length of the oil pipe shall not exceed 8m.

The operator shall check the installation and use requirements of the flowmeter before discharging the oil:

- The unloading flowmeter shall be installed according to the above requirements, and the flowmeter outlet shall be located at the lowest point;
- The pipeline connecting the tank and the flowmeter shall be no less than 80mm in diameter and no more than 8m in length, and flow smoothly when unloading oil
- unloading flowmeter is non-interruptible flowmeter and cannot be used in oil retail
- unloading flowmeter is not suitable for pressurized oil unloading of oil pump.

3. User menu



The display metering module has no switch and the display is always on. Reset is required before starting the new test. Save and reset the last measurement data and display the current data. Each button should last 3 seconds

- 12345678.56L---Volume
- GASOIL-----Fuel Type
- 20200619-----Time
- IDLE-----Running status

3.1 Start unloading oil (manual opening only)

First, make sure the oil is correct, press SEL key, RUN is flashing, then press VAL key to confirm and start unloading. After unloading, press RAZ key to save or clear the data for next test. (Data can be deleted only during this process, but can't be deleted after saving)

3.2 Oil switch (Manual /APP operation)

Press SEL key to switch to oil name flashing, press VAL key to enter oil product switching interface, press VAL key to switch gasoline/diesel, press SEL key to switch to OK flashing, press VAL key to confirm return. APP operation to switch oil products for details, see the Appendix.

3.3 Historical data query (Manual /APP operation)

Press RAZ key to enter the historical data query interface. Press RAZ/VAL key to view it from top to bottom. APP operation data query for details, see the Appendix.

3.4 Coefficient change (Manual /APP operation)

Press SEL key, switch to oil name flashing, press RAZ key to enter the password interface, the password is 000001, switch to OK flashing, press VAL key to confirm to enter the coefficient modification interface, FPC is the working coefficient of two dry and wet sensors, HPC is the working coefficient of one dry and wet sensor. APP operation to correction coefficient for details, see the Appendix.

3.5 The Password Cannot Be Changed (The Password is 000001)

Press SEL key to switch to oil name flashing, press RAZ key to enter the password input interface, the password is 000001.

3.6 Date Cannot be Modified (Sync with APP)

After the flowmeter connects to the mobile APP, the date will be updated automatically without manual setting.

3.7 Storage

The flowmeter stores 1000 pieces of data by default.

4. External mounting dimensions

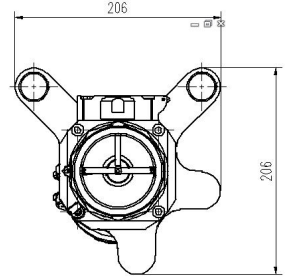
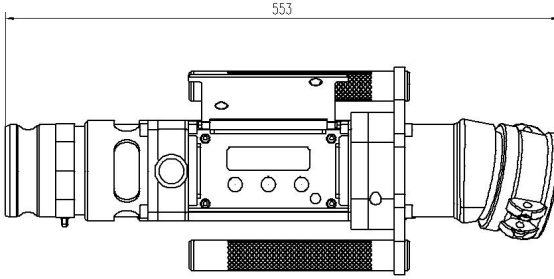

Operation of Bluetooth Transmission

- I. Installation of mobile APP (Android system only);
- II. Introduction to rechargeable batteries;
- III. Bluetooth connection steps (Android system only)
- IV. Coefficient modification, language switching, oil product switching and record query



I. Installation of mobile APP (Android system only)

1. Copy the link and download the APP (Figure 1):

<http://api.lead-fun.cn/apk/APP.apk>



Figure 1

2. After successful installation, open the default English interface for the first time (see IV.1 for language switch operation; Figure 2, 3, 4).



Figure 2



Figure 3



Figure 4

II. Introduction to rechargeable batteries

1. The flowmeter adopts a model: FRT-FB101S01, specification:
3.7V/1800mAh rechargeable explosion-proof lithium ion battery.
2. Battery life:
 - ① After 300 cycles of charging, about 75% of each charge is left;
 - ② After 500 cycles of charging, the amount of each charge is about 65%.
3. In order to protect the battery life cycle, be sure to use the specified power adapter specifications (the product comes with one).
Charging limit voltage: 4.2V; (1) Input:AC100-240V 50/60Hz;
(2) Output: 4.2V/1A;
4. Introduction to electric quantity display (Figure 5):





Voltage	Icon
>3.70V	
3.45V to 3.70V	
3.2V to 3.45V	
<3.20V	
Note: The voltage error is 0.05V	

Figure 5

5. Charging method:

One side of the controller box is provided with a charging port. Under normal circumstances, a special cover is used to seal the charging port to prevent conductive foreign bodies from entering the charging port and causing short circuit and no display.

Therefore, attention must be paid to the use, except for the state of charging when the special cover is opened, other circumstances should not be opened (Figure 6).



Figure 6

6. Full power tips:

The power adapter comes with the power indicator, which shows **red** when it is charged and **green** when it is fully charged.

Under normal circumstances, it takes **5-6 hours** to be fully charged (Figure 7, 8).

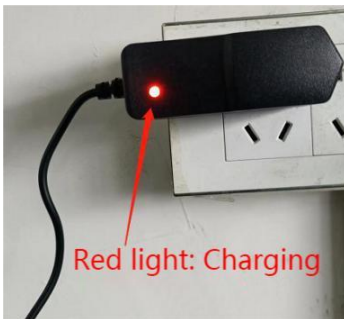

Figure 7



Figure 8

III. Bluetooth connection steps (Android system only)

1. When the distance between the mobile phone and the flowmeter is within the effective range of Bluetooth.
2. Open the flowmeter control box cover and open the Settings of the mobile phone at the same time.
3. Click on the Bluetooth function, and search for the Bluetooth name: LEADFUN_BLEXXX(the last three X stands for number, Bluetooth serial number), for example: LEADFUN_BLE003.
4. Click the Bluetooth, and it will prompt that the Bluetooth pairing between the mobile phone and the flowmeter is successful.
5. Continue to click the Bluetooth connection at the upper right corner of the APP of the mobile phone, and the dialog box for entering the Bluetooth serial number will pop up.
6. Enter the three digits after the Bluetooth serial number found by the mobile phone, and it will prompt that the connection is successful (Figure 9, 10, 11) :



Figure 9

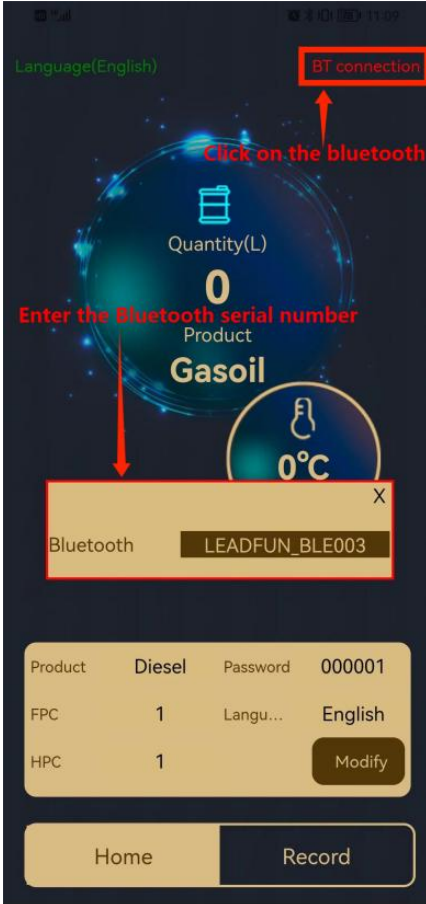

Figure 10

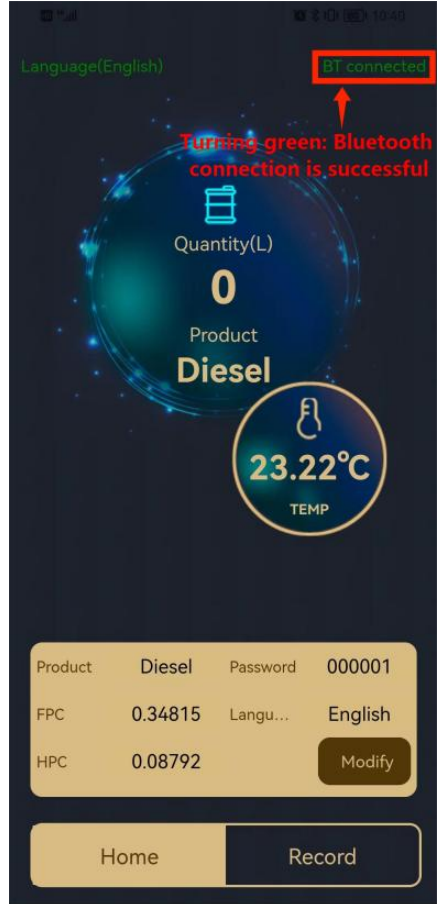

Figure 11

IV. Coefficient modification, language switching, oil product switching and record query

1. Language switching

- ① Click the command "Modify", and the password is prompted.
The original password is **8888** (Figure 12).
- ② Click "Language", and there are three language options: Chinese, English and Spanish (Figure 13).
- ③ Click the required language to turn into the corresponding language interface (Figure 14, 15, 16).

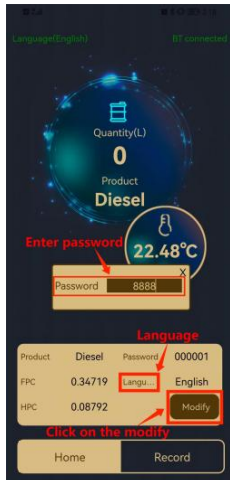

Figure 12

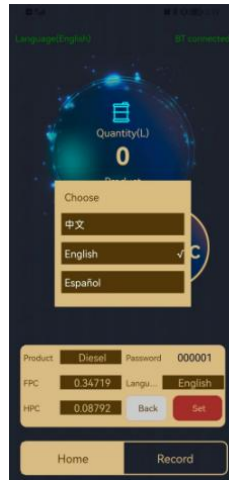

Figure 13



Figure 14

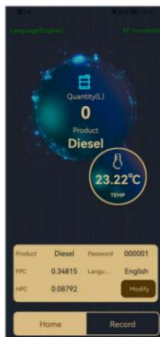

Figure 15

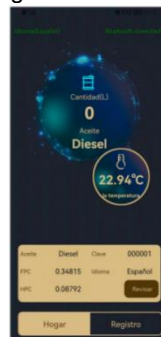

Figure 16

2. Switch oil products

- ① Click "Modify" (Figure 17), and the oil selection dialog box will appear: gasoline, diesel.
- ② After clicking the corresponding oil product (FPC and HPC can also be modified together if you need), click "Set".
There will be a voice notification that the switch has been successful (take gasoline as an example, Figure 18).
- ③ The steps for setting diesel are the same as above.



Figure 17

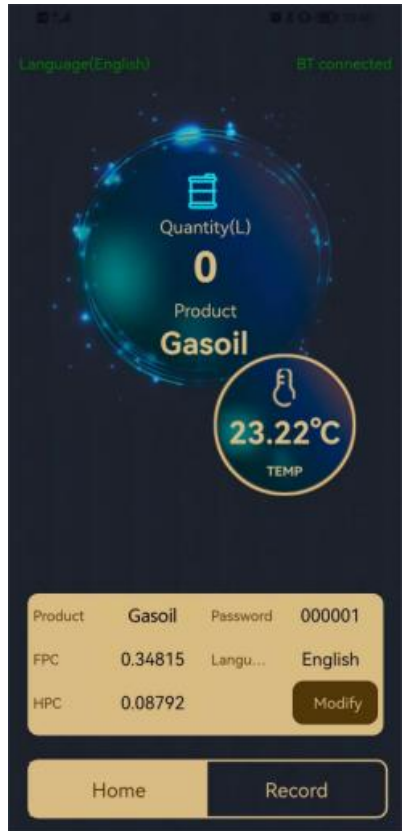

Figure 18

3. Record query

- ①After the success of the bluetooth connection, click on the lower right corner interface "record".
- ②Click on the top right corner "Read all", which shows all recorded data, flowmeter store 1000 data by default (Figure 19).
- ③Click on the "Export Excel", Save the records to the phone in the form of Excel sheet.

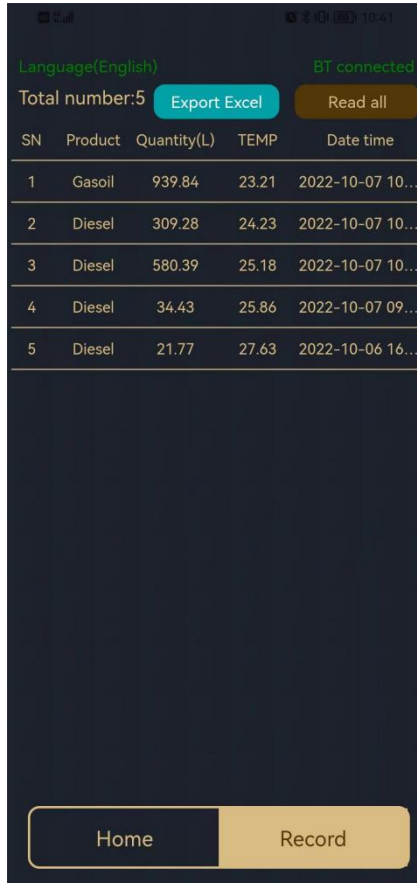

Figure 19

JIASONG[®]
J A S E N T

ZHEJIANG JIASONG TECHNOLOGY CO., LTD

PUYI INDUSTRIAL ZONE, OUBEI TOWN,
YONGJIA, WENZHOU, ZHEJIANG, CHINA, 325105.

JIASONG[®]
J A S E N T

Add: Puyi Industrial Zone, Oubei Town,

Yongjia, Zhejiang China

Tel.: 0577-67353517

Fax: 0577-67355517

Zip Cod: 325105

Web: <http://www.jiasongchina.com>